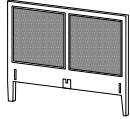

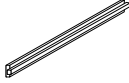







Table Parts & Hardware

A		x 1 PC
B		x 1 PC
C		x 2 PC
D		x 1 PC
E		x 28 PC
F		x 1 PC
G		x 8 PC
H		x 8 PC
I		x 1 PC

Garden Trading®

Chesterton King Bed Assembly Instructions

Please read through these instructions and ensure they are kept for future reference.
All parts and hardware are listed on the back of this guide.

WHEN ASSEMBLING THIS PRODUCT PLEASE PLACE PARTS ON A SOFT SURFACE TO AVOID DAMAGE OR SCRATCHES.

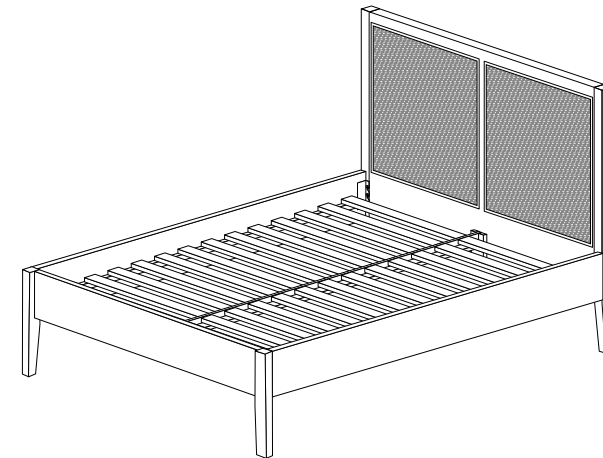

Care Instructions

This product is made from Bayur Wood. Wood is a natural material and natural colour variances may occur.

To keep your bed clean, we advise dusting regularly with a small brush or vacuum. Any spillages should be wiped clean with a damp cloth immediately in the direction of the grain.

To preserve its condition and avoid fading over time, avoid exposing your furniture to direct sunlight. Discolouration may occur and cause the wood to crack.

We recommend keeping your bed away from heat sources like fireplaces or radiators - plus moisture - to prevent warping.

Please do not drag the furniture, we recommend to always lift it to move, avoiding any breakages.

Garden Trading®

gardentrading.co.uk

customerservices@gardentrading.co.uk

TGTC, Hargreaves Road, Groundwell Industrial Estate, Swindon, SN25 5AZ

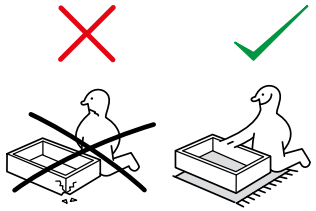

- ① Add the included bolts H to A and B, finger tighten, attach C then tighten using a spanner I.

