







## Table Parts & Hardware

A		x 8 PC
B		x 8 PC
C		x 4 PC
D		x 12 PC
E		x 1 PC
F		x 1 PC

# Garden Trading®

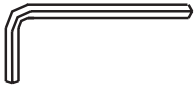
## Titchberry Loveseat Assembly Instructions

Please read through these instructions and ensure they are kept for future reference.  
All parts and hardware are listed on the back of this guide.

**WHEN ASSEMBLING THIS PRODUCT PLEASE PLACE PARTS  
ON A SOFT SURFACE TO AVOID DAMAGE OR SCRATCHES.**

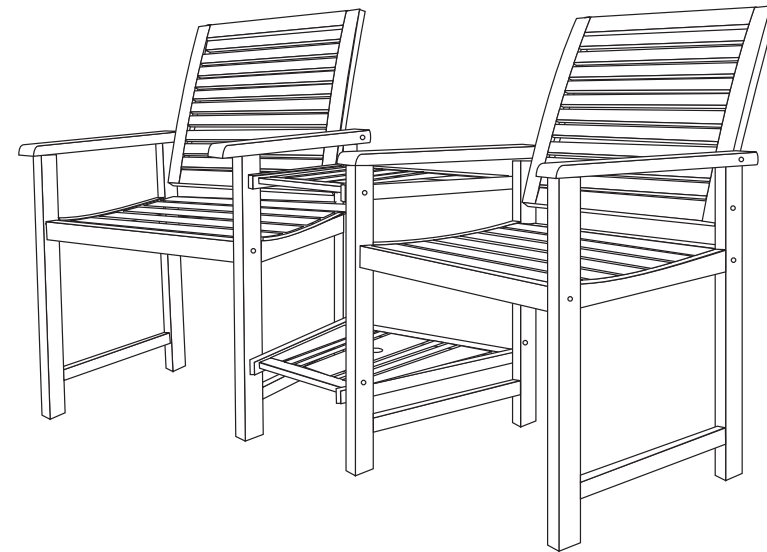

### Care Instructions

We advise dusting your loveseat regularly with a clean, dry cloth to maintain its condition.  
In the event of any spills, wipe surfaces immediately with a damp cloth and then rub down with a clean dry cloth.  
Never use abrasive or corrosive cleaning agents on any area of your loveseat.  
Do not drag your furniture; always lift your loveseat to move it.  
We recommend storing your loveseat inside or undercover to preserve its condition during the winter months.  
We recommend that a base is needed to support a parasol, if used.

# Garden Trading®

[gardentrading.co.uk](http://gardentrading.co.uk)

[customerservices@gardentrading.co.uk](mailto:customerservices@gardentrading.co.uk)

TGTC, Hargreaves Road, Groundwell Industrial Estate, Swindon, SN25 5AZ

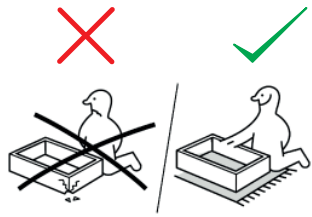

①

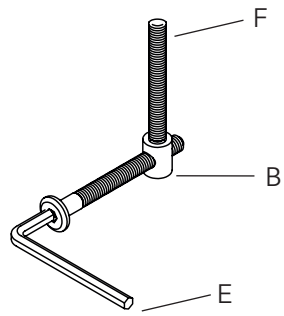

②

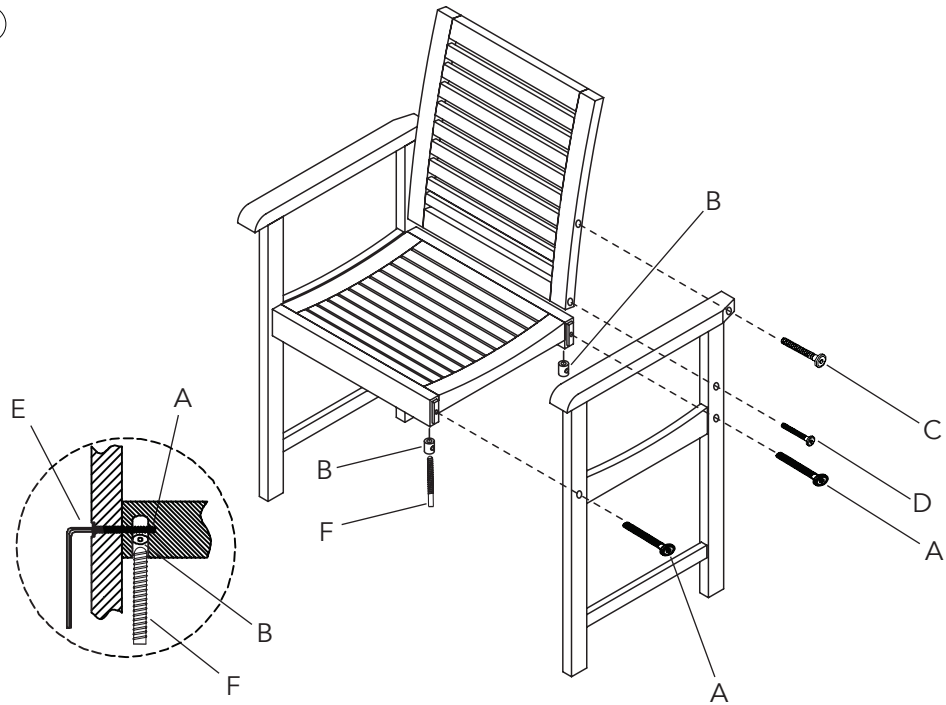

③

