

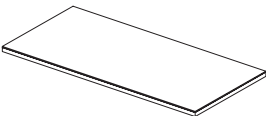

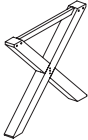

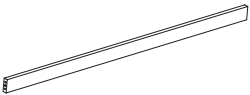

### Parts & Hardware

A		x 1 PC
B		x 2 PCs
C		x 1 PC
D		x 2 PCs M7 x 90mm
E		x 8 PCs M8 x 150
F		x 16 PCs M8
G		x 16 PCs M8
H		x 8 PCs M8
I		x 4 PCs 10x30mm
J		x 2 PCs K13
K		x 1 PC

# Garden Trading®

## Burford Table, Small Assembly Instructions

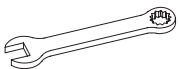
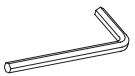
Please read through these instructions and ensure they are kept for future reference.  
All parts and hardware are listed on the back of this guide.

**WHEN ASSEMBLING THIS PRODUCT PLEASE PLACE PARTS ON A SOFT SURFACE TO AVOID DAMAGE OR SCRATCHES.**

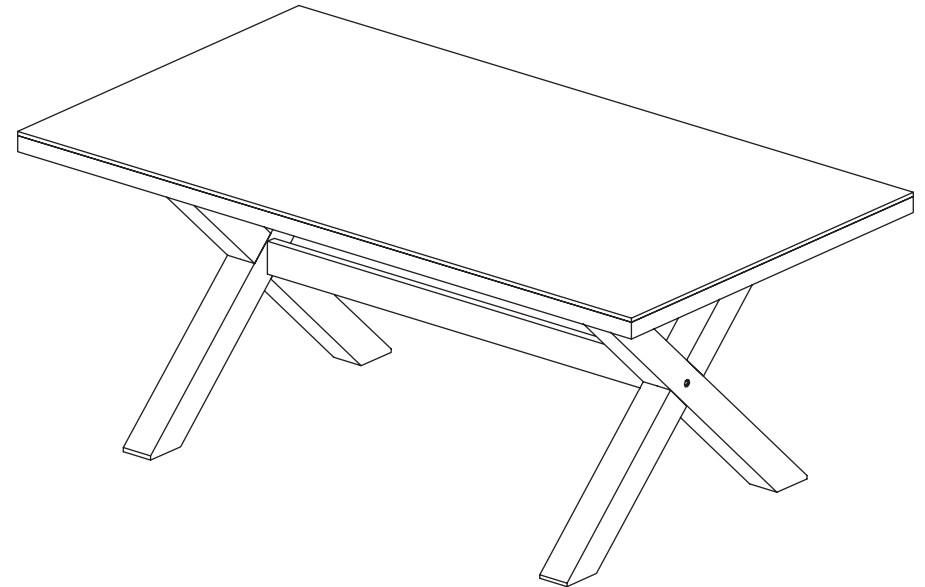

### Care Instructions

Dust regularly with a clean dry cloth.

Wipe up any spills immediately with a damp cloth and then dry the surface with a clean dry cloth.

Never use abrasive or corrosive cleaning agents.

Avoid placing on uneven surfaces.

Do not drag furniture, always lift to move.

We recommend storing inside over winter months.

Customer Services:

[gardentrading.co.uk](http://gardentrading.co.uk)

+44 (0)1993 845 559

[customerservices@gardentrading.co.uk](mailto:customerservices@gardentrading.co.uk)

Opening Hours: Monday - Friday: 8.30am - 5.30pm (Friday close at 5.00pm)

The Garden Trading Company Ltd, Carterton South Industrial Estate, Black Bourton Road, Carterton, Oxon, OX18 3EZ

# Garden Trading®

